



M41T56C64

Serial Real Time Clock with 56 bytes of NVRAM
+ 64 Kbit (8192 bit x 8) EEPROM

Feature summary

- 5V \pm 10% supply voltage
- I²C bus compatible
- Operating temperature of –40 to 85°C
- Packaging includes:
 - 18-lead SOIC (with embedded crystal)
- RoHS compliant

Serial RTC features

- Counters for seconds, minutes, hours, day, date, month, years, and century
- Embedded crystal package
- Software clock calibration
- Automatic power-fail detect and switch circuitry
- 56 bytes of general purpose SRAM
- Ultra-low battery supply current of 450nA
- Automatic leap year compensation
- Special software programmable output
- Two-wire I²C serial interface supports 100kHz protocol

Serial EEPROM features

- 8192 bytes of general purpose EEPROM (more than 1e6 erase/write cycles)
- Two-wire I²C serial interface supports 400kHz protocol
- Byte and page write (up to 32 bytes)
- More than 40 year data retention
- Self-timed programming cycle

Embedded crystal

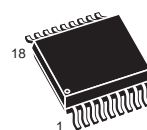

SOX18(MY)
18-pin (300mil) SOIC

Contents

1	Summary description	5
	1.1 Calibration	5
2	Pin settings	6
	2.1 Pin description	6
	2.2 Pin connections	6
3	Application	7
4	Operation	9
	4.1 Serial RTC device	9
	4.2 EEPROM device	9
5	Maximum rating	10
6	DC and AC parameters	11
7	Package mechanical data	15
8	Order codes	17
9	Revision history	18

List of tables

Table 1.	Signal names	6
Table 2.	Device select code	8
Table 3.	Absolute maximum ratings	10
Table 4.	Operating and AC measurement conditions.	11
Table 5.	Capacitance and input parameters.	12
Table 6.	DC characteristics.	12
Table 7.	AC characteristics, (serial RTC, M41T56)	13
Table 8.	AC characteristics (Serial EEPROM, M24C64)	14
Table 9.	SOX18 – 18-lead plastic small outline, 300mils, embedded crystal, package mech.	16
Table 10.	Ordering information scheme	17
Table 11.	Revision history	18

List of figures

Figure 1.	Logic diagram	5
Figure 2.	18-pin SOIC connection	6
Figure 3.	Block diagram	7
Figure 4.	Crystal accuracy across temperature	7
Figure 5.	AC measurement I/O waveform	11
Figure 6.	AC Bus timing requirements sequence (serial RTC)	13
Figure 7.	SOX18 – 18-lead plastic small outline, 300mils, embedded crystal	16

1 Summary description

The M41T56C64 is a low power, Serial Real Time Clock with 56 bytes of NVRAM plus a 64Kb EEPROM (see [Figure 3](#)). A built-in 32,768Hz oscillator (crystal controlled) and the first 8 bytes of the RAM are used for the clock/calendar function and are configured in binary coded decimal (BCD) format. Addresses and data are transferred serially via a two-line, bi-directional bus. The built-in address register is incremented automatically after each WRITE or READ data byte.

The M41T56C64 clock has a built-in power sense circuit which detects power failures and automatically switches to the battery supply during power failures. The energy needed to sustain the RAM and clock operations can be supplied from a small lithium coin cell.

Typical data retention time for the Serial RTC is in excess of 10 years with a 50mAh, 3V lithium cell. The M41T56C64 is supplied in an 18-lead Plastic SOIC package.

1.1 Calibration

As the crystal is molded together with the silicon in this package, ST can program the appropriate calibration value necessary to achieve ± 5 ppm accuracy at 25°C after two SMT reflows (see [Figure 4](#)). This calibration value will be written into address 1550h of the EEPROM. This clock accuracy can then be guaranteed to drift no more than ± 3 ppm the first year, and ± 1 ppm for each following year due to crystal aging.

Figure 1. Logic diagram

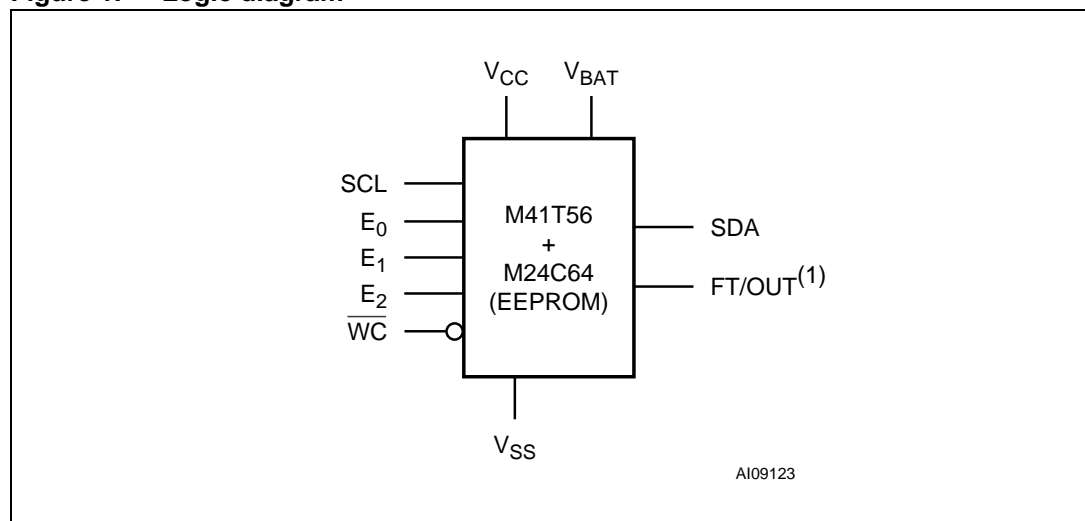

1. Open drain output

2 Pin settings

2.1 Pin description

Table 1. Signal names

FT/OUT ⁽¹⁾	Frequency test / output driver (open drain)
SDA	Serial data address input / output
SCL	Serial clock
\overline{WC}	Write control
E0, E1, E2	Chip enables
V _{BAT}	Battery supply voltage
V _{CC}	Supply voltage
V _{SS}	Ground
NC ⁽²⁾	No connect
NF ⁽³⁾	No function

1. Open drain output
2. No connect (NC) pins should be tied to V_{SS}.
3. No function (NF) pins should be tied to V_{SS}. Pins 2 and 3, and pins 16 and 17 are internally shorted together.

2.2 Pin connections

Figure 2. 18-pin SOIC connection

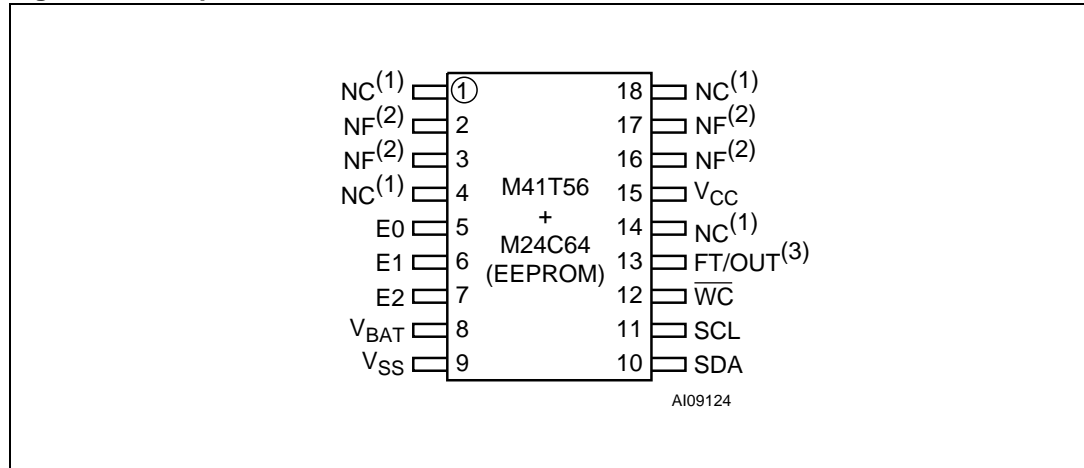

1. No connect (NC) pins should be tied to V_{SS}
2. No function (NF) pins should be tied to V_{SS}. Pins 2 and 3, and pins 16 and 17 are internally shorted together.
3. Open drain output

3 Application

Figure 3. Block diagram

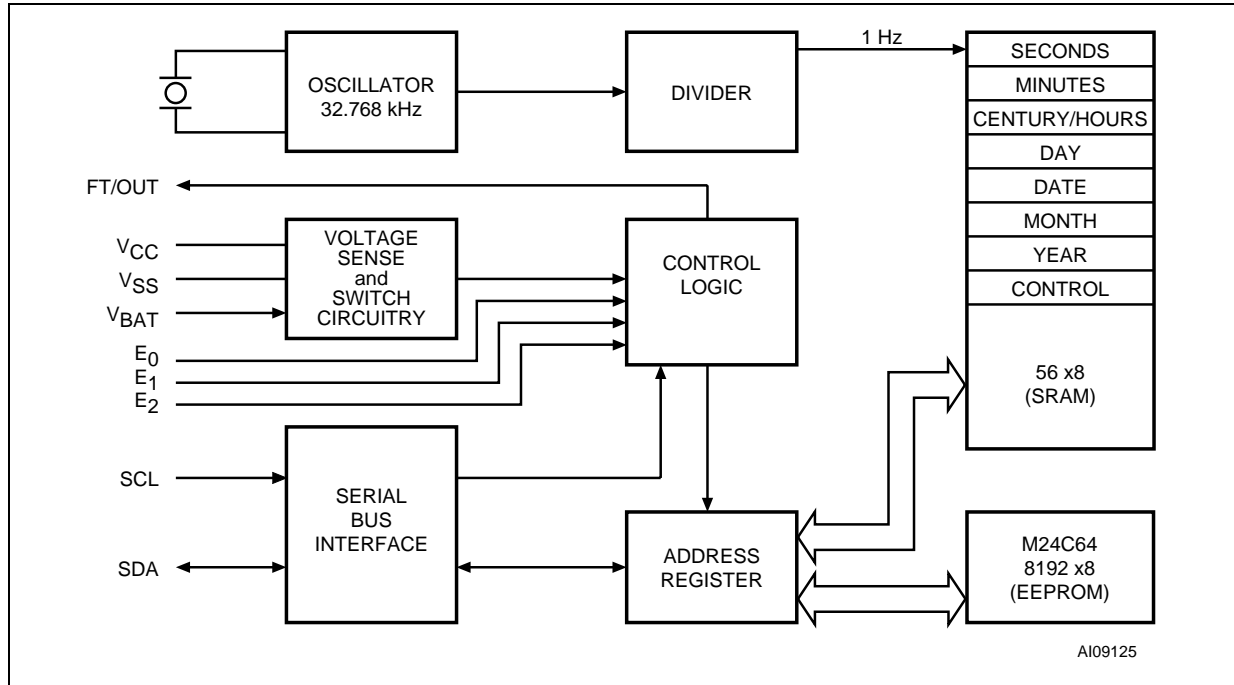

Figure 4. Crystal accuracy across temperature

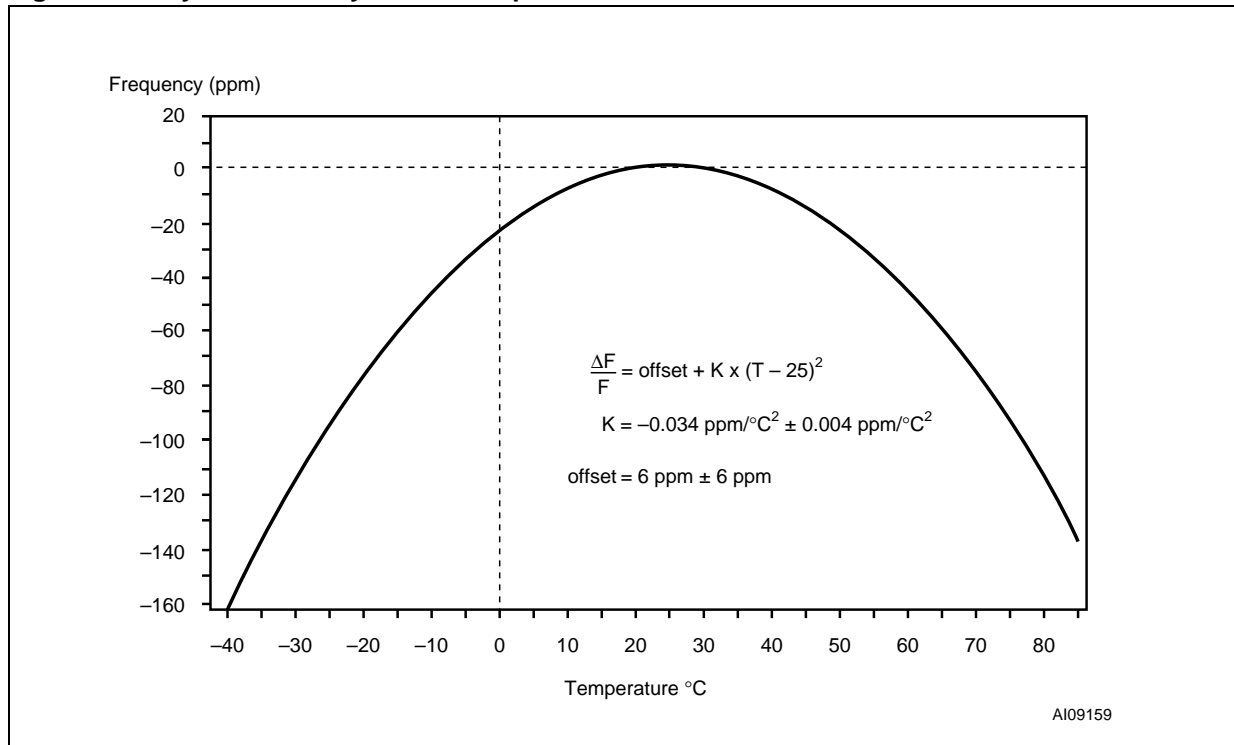

Table 2. Device select code

	Device type identifier ⁽¹⁾				Chip enable address ⁽²⁾			R \overline{W}
	b7	b6	b5	b4	b3	b2	b1	b0
M24C64	1	0	1	0	E2	E1	E0	R \overline{W}
M41T56	1	1	0	1	0	0	0	RW

1. The most significant bit, b7, is sent first.
2. E0, E1, and E2 are compared against the respective external pins on the memory device.

4 Operation

4.1 Serial RTC device

The M41T56C64 contains one Serial RTC (M41T56). For detailed information on how to use the devices, see the M41T56 datasheet, which is available from your local STMicroelectronics distributor or from the STMicroelectronics website, <http://www.st.com/rtc/>.

4.2 EEPROM device

The M41T56C64 contains a 64 Kbit Serial EEPROM (M24C64). For detailed information on how to use the devices, see the M24C64 datasheet, which is available from your local STMicroelectronics distributor or from the STMicroelectronics website, <http://www.st.com/eeprom/>.

5 Maximum rating

Stressing the device above the rating listed in the “absolute maximum ratings” table may cause permanent damage to the device. These are stress ratings only and operation of the device at these or any other conditions above those indicated in the Operating sections of this specification is not implied. Exposure to absolute maximum rating conditions for extended periods may affect device reliability. Refer also to the STMicroelectronics SURE program and other relevant quality documents.

Table 3. Absolute maximum ratings

Symbol	Parameter	Value	Unit
T_A	Ambient operating temperature	-40 to 85	°C
T_{STG}	Storage temperature (V_{CC} off, oscillator off)	-55 to 125	°C
$T_{SLD}^{(1)}$	Lead solder temperature for 10 seconds	240	°C
V_{IO}	Input or output voltages	-0.3 to 6.5	V
V_{CC}	Supply voltage	-0.3 to 6.5	V
I_O	Output current	20	mA
P_D	Power dissipation	0.25	W

1. For SOX18 package, Lead-free (Pb-free) lead finish: Reflow at peak temperature of 240°C (total thermal budget not to exceed 180°C for between 90 to 150 seconds). No direct exposure to infrared (IR) reflow, or IR preheat allowed, to avoid damaging the embedded 32KHz crystal.

Caution: *Negative undershoots below -0.3V are not allowed on any pin while in the battery back-up mode.*

6 DC and AC parameters

This section summarizes the operating and measurement conditions, as well as the DC and AC characteristics of the device. The parameters in the following DC and AC characteristic tables are derived from tests performed under the measurement conditions listed in the relevant tables. Designers should check that the operating conditions in their projects match the measurement conditions when using the quoted parameters.

Table 4. Operating and AC measurement conditions⁽¹⁾

Parameter	Value	Unit
Supply voltage (V_{CC})	4.5 to 5.5	V
Ambient operating temperature (T_A)	-40 to 85	°C
Load capacitance (C_L)	100	pF
Input rise and fall times	50 (max)	ns
Input pulse voltages	$0.2V_{CC}$ to $0.8V_{CC}$	V
Input and output timing ref. voltages	$0.3V_{CC}$ to $0.7V_{CC}$	V

1. Output Hi-Z is defined as the point where data is no longer driven.

Figure 5. AC measurement I/O waveform

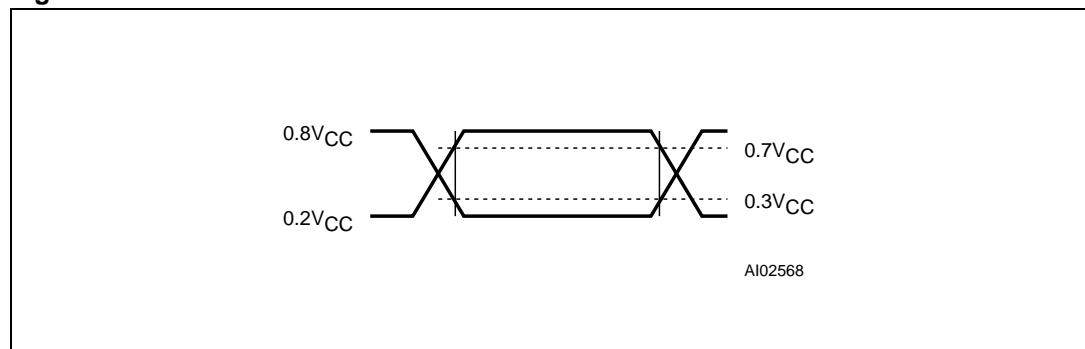

Table 5. Capacitance and input parameters

Symbol	Parameter ^{(1) (2)}	Test condition	Min	Max	Unit
C _{IN}	Input capacitance (SCL)			13	pF
	Input capacitance (SDA)			18	pF
	Input Capacitance (Other pins)			6	pF
Z _{WCL}	\overline{WC} input impedance	V _{IN} < 0.5V	5	20	kΩ
Z _{WCH}	\overline{WC} input impedance	V _{IN} < 0.7V _{CC}	500		kΩ
C _{OUT} ⁽³⁾	Output capacitance (SDA)			18	pF
	Output capacitance (FT/OUT)			10	pF

1. Effective capacitance measured with power supply at 5V; sampled, not 100% tested.
2. At 25°C, f = 400kHz..
3. Outputs deselected.

Table 6. DC characteristics

Symbol	Parameter	Test Condition ⁽¹⁾	Min	Typ	Max	Unit
I _{LI}	Input leakage current	0V ≤ V _{IN} ≤ V _{CC}			±3	μA
I _{LO}	Output leakage current	0V ≤ V _{OUT} ≤ V _{CC}			±3	μA
I _{CC1}	Supply current (Serial RTC active)	Switch frequency = 100kHz			310	μA
	Supply current (Serial EEPROM active)	V _{CC} = 5V, f _c =400kHz (rise/fall time < 30ns)			2.2	mA
I _{CC2}	Supply current (standby)	SCL, SDA = V _{CC} - 0.3V		100		μA
V _{IL}	Input low voltage (SCL, SDA)		-0.3		1.5	V
	Input low voltage (E2, E1, E0)		-0.45		0.3V _{CC}	V
	Input low voltage (\overline{WC})		-0.45		0.5	V
V _{IH}	Input high voltage (SCL, SDA)		3		V _{CC} + 0.8	V
	Input high voltage (E2, E1, E1, \overline{WC})		0.7V _{CC}		V _{CC} + 1	V
V _{OL}	Output low voltage	I _{OL} = 3mA, V _{CC} = 5V			0.4	V
V _{BAT} ⁽²⁾	Battery supply voltage		2.5	3	3.5	V
I _{BAT}	Battery supply current	T _A = 25°C, V _{CC} = 0V, Oscillator ON, V _{BAT} = 3V		450	550	nA

1. Valid for ambient operating temperature: T_A = -40 to 85°C; V_{CC} = 4.5 to 5.5V (except where noted).
2. STMicroelectronics recommends the RAYOVAC BR1225 or BR1632 (or equivalent) as the battery supply.

Figure 6. AC Bus timing requirements sequence (serial RTC)

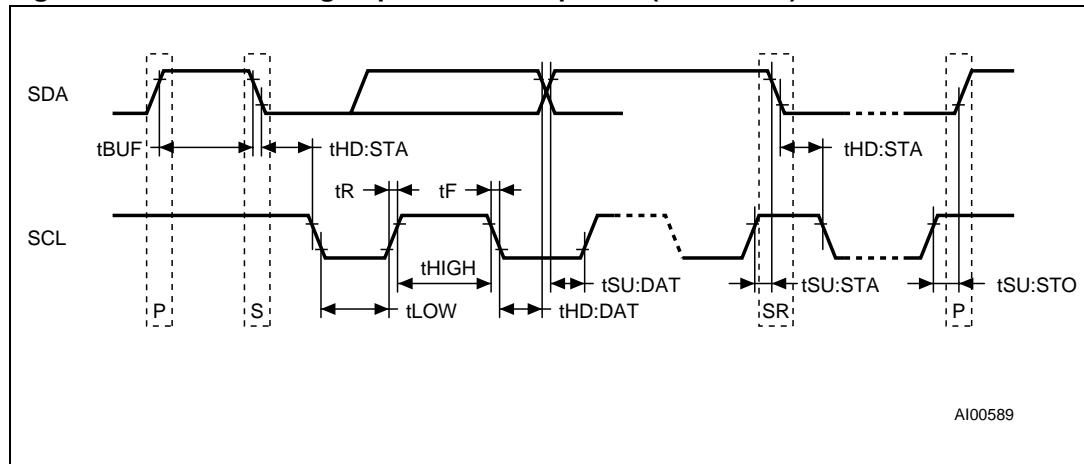

Table 7. AC characteristics, (serial RTC, M41T56)

Symbol	Parameter ⁽¹⁾	Min	Max	Unit
f_{SCL}	SCL clock frequency	0	100	kHz
t_{LOW}	Clock low period	4.7		μ s
t_{HIGH}	Clock high period	4		μ s
t_{R}	SDA and SCL rise time		1	μ s
t_{F}	SDA and SCL fall time		300	ns
$t_{HD:STA}$	START condition hold time (after this period the first clock pulse is generated)	4		μ s
$t_{SU:STA}$	START condition setup time (only relevant for a repeated start condition)	4.7		μ s
$t_{SU:DAT}$	Data setup time	250		ns
$t_{HD:DAT}^{(2)}$	Data hold time	0		μ s
$t_{SU:STO}$	STOP condition setup time	4.7		μ s
t_{BUF}	Time the bus must be free before a new transmission can start	4.7		μ s
t_{LP}	Low-pass filter input time constant (SDA and SCL) for Serial RTC	0.25	1	μ s

- Valid for ambient operating temperature: $T_A = -40$ to 85°C ; $V_{CC} = 4.5$ to 5.5V (except where noted).
- Transmitter must internally provide a hold time to bridge the undefined region (300ns max.) of the falling edge of SCL.

Table 8. AC characteristics (Serial EEPROM, M24C64)

Symbol	Alt.	Parameter	Test condition	Min.	Max.	Unit
f_C	f_{SCL}	Clock frequency			400	kHz
t_{CHCL}	t_{HIGH}	Clock pulse width high		600		ns
t_{CLCH}	t_{LOW}	Clock pulse width low		1300		ns
$t_{DL1DL2}^{(1)}$	t_F	SDA fall time		20	300	ns
t_{DXCX}	$t_{SU:DAT}$	Data in set up time		100		ns
t_{CLDX}	$t_{HD:DAT}$	Data in hold time		0		ns
t_{CLQX}	t_{DH}	Data out hold time		200		ns
$t_{CLQV}^{(2)}$	t_{AA}	Clock low to next data valid (access time)		200	900	ns
$t_{CHDX}^{(3)}$	$t_{SU:STA}$	Start condition set up time		600		ns
t_{DLCL}	$t_{HD:STA}$	Start condition hold time		600		ns
t_{CHDH}	$t_{SU:STO}$	Stop condition set up time		600		ns
t_{DHDL}	t_{BUF}	Time between stop condition and next start condition		1300		ns
t_W	t_{WR}	Write time			5	ms
t_{NS}		Pulse width ignored (input filter on SCL and SDA for serial EEPROM)	Single glitch		100	ns

1. Sampled only, not 100% tested.
2. To avoid spurious START and STOP conditions, a minimum delay is placed between SCL=1 and the falling or rising edge of SDA.
3. For a reSTART condition, or following a Write cycle.

7 Package mechanical data

In order to meet environmental requirements, ST offers these devices in ECOPACK® packages. These packages have a Lead-free second level interconnect . The category of second level interconnect is marked on the package and on the inner box label, in compliance with JEDEC Standard JESD97. The maximum ratings related to soldering conditions are also marked on the inner box label. ECOPACK is an ST trademark. ECOPACK specifications are available at: www.st.com

Figure 7. SOX18 – 18-lead plastic small outline, 300mils, embedded crystal

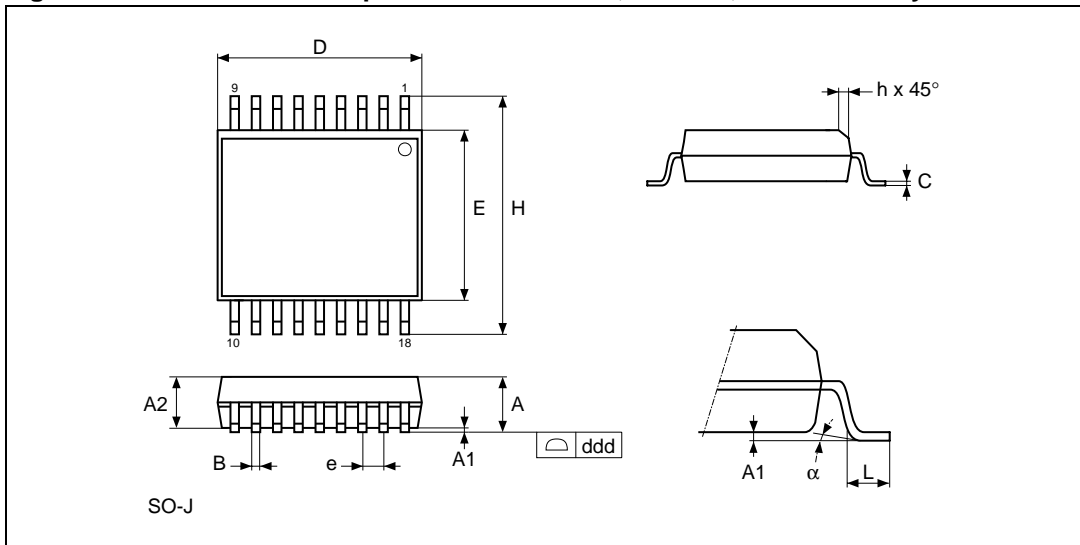

1. Drawing is not to scale.

Table 9. SOX18 – 18-lead plastic small outline, 300mils, embedded crystal, package mech.

Symbol	millimetres			inches		
	Typ	Min	Max	Typ	Min	Max
A		2.44	2.69		0.096	0.106
A1		0.15	0.31		0.096	0.012
A2		2.29	2.39		0.090	0.094
B		0.41	0.51		0.016	0.020
C		0.20	0.31		0.008	0.012
D	11.61	11.56	11.66	0.457	0.455	0.459
ddd			0.10			0.004
E		7.57	7.67		0.298	0.302
e	1.27	–	–	0.050	–	–
H		10.16	10.52		0.400	0.414
L		0.51	0.81		0.020	0.032
a		0°	8°		0°	8°
N		18			18	

8 Order codes

Table 10. Ordering information scheme

Example:	M41T	56	C64	MY	6	E
Device type						
M41T = Serial RTC						
Supply voltage and write protect voltage						
56 = $V_{CC} = 4.5$ to $5.5V$						
EEPROM density						
C64 = 64 Kbit (8192 bit x 8)						
Package						
MY ⁽¹⁾ = SOX18						
Temperature range						
6 = $-40^{\circ}C$ to $85^{\circ}C$						
Shipping method						
E = ECOPACK® package, tubes						
F = ECOPACK® package, tape & reel						

1. The SOX18 package includes an embedded 32,768Hz crystal.

For other options, or for more information on any aspect of this device, please contact the ST Sales Office nearest you.

9 Revision history

Table 11. Revision history

Date	Version	Description
14-Sep-2004	1	First Edition
25-Mar-2005	2	Clarify pin connections, maximum rating
4-Sep-2006	3	Datasheet status updated to full datasheet; changed title on page 1; small text changes to Section 1: Summary description ; reformatted figure in the Feature summary , reformatted Figure 1 , Figure 2 , Table 2 and Table 9 ; ecopack compliant; updated disclaimer
22-Sep-2006	4	Added information on EEPROM density Table 10: Ordering information scheme

Please Read Carefully:

Information in this document is provided solely in connection with ST products. STMicroelectronics NV and its subsidiaries ("ST") reserve the right to make changes, corrections, modifications or improvements, to this document, and the products and services described herein at any time, without notice.

All ST products are sold pursuant to ST's terms and conditions of sale.

Purchasers are solely responsible for the choice, selection and use of the ST products and services described herein, and ST assumes no liability whatsoever relating to the choice, selection or use of the ST products and services described herein.

No license, express or implied, by estoppel or otherwise, to any intellectual property rights is granted under this document. If any part of this document refers to any third party products or services it shall not be deemed a license grant by ST for the use of such third party products or services, or any intellectual property contained therein or considered as a warranty covering the use in any manner whatsoever of such third party products or services or any intellectual property contained therein.

UNLESS OTHERWISE SET FORTH IN ST'S TERMS AND CONDITIONS OF SALE ST DISCLAIMS ANY EXPRESS OR IMPLIED WARRANTY WITH RESPECT TO THE USE AND/OR SALE OF ST PRODUCTS INCLUDING WITHOUT LIMITATION IMPLIED WARRANTIES OF MERCHANTABILITY, FITNESS FOR A PARTICULAR PURPOSE (AND THEIR EQUIVALENTS UNDER THE LAWS OF ANY JURISDICTION), OR INFRINGEMENT OF ANY PATENT, COPYRIGHT OR OTHER INTELLECTUAL PROPERTY RIGHT.

UNLESS EXPRESSLY APPROVED IN WRITING BY AN AUTHORIZED ST REPRESENTATIVE, ST PRODUCTS ARE NOT RECOMMENDED, AUTHORIZED OR WARRANTED FOR USE IN MILITARY, AIR CRAFT, SPACE, LIFE SAVING, OR LIFE SUSTAINING APPLICATIONS, NOR IN PRODUCTS OR SYSTEMS WHERE FAILURE OR MALFUNCTION MAY RESULT IN PERSONAL INJURY, DEATH, OR SEVERE PROPERTY OR ENVIRONMENTAL DAMAGE. ST PRODUCTS WHICH ARE NOT SPECIFIED AS "AUTOMOTIVE GRADE" MAY ONLY BE USED IN AUTOMOTIVE APPLICATIONS AT USER'S OWN RISK.

Resale of ST products with provisions different from the statements and/or technical features set forth in this document shall immediately void any warranty granted by ST for the ST product or service described herein and shall not create or extend in any manner whatsoever, any liability of ST.

ST and the ST logo are trademarks or registered trademarks of ST in various countries.

Information in this document supersedes and replaces all information previously supplied.

The ST logo is a registered trademark of STMicroelectronics. All other names are the property of their respective owners.

© 2006 STMicroelectronics - All rights reserved

STMicroelectronics group of companies

Australia - Belgium - Brazil - Canada - China - Czech Republic - Finland - France - Germany - Hong Kong - India - Israel - Italy - Japan - Malaysia - Malta - Morocco - Singapore - Spain - Sweden - Switzerland - United Kingdom - United States of America

www.st.com

